



Republic of the Philippines
Main Campus, Sogod, Southern Leyte
email: ssumaincampus@gmail.com/
op@slsuonline.edu.ph telefax: (053) 577-8299



PHILIPPINE BIDDING DOCUMENTS

(As Harmonized with Development Partners)

Government of the Republic of the Philippines

REHABILITATION OF FISHPOND WITH ADVANCED POND FACILITIES IN SLSU BONTOC CAMPUS (CY 2022 EPA) ABC: ₱14,844,022.32

Pre-bid Conference: **17 December 2021 – 10:30 AM**
Submission/Opening of Bids: **29 December 2021 – 10:30 AM**

PB EPA 2022-IP-02

**Sixth Edition
July 2020**

Preface

These Philippine Bidding Documents (PBDs) for the procurement of Infrastructure Projects (hereinafter referred to also as the “Works”) through Competitive Bidding have been prepared by the Government of the Philippines for use by all branches, agencies, departments, bureaus, offices, or instrumentalities of the government, including government-owned and/or -controlled corporations, government financial institutions, state universities and colleges, local government units, and autonomous regional government. The procedures and practices presented in this document have been developed through broad experience, and are for mandatory use in projects that are financed in whole or in part by the Government of the Philippines or any foreign government/foreign or international financing institution in accordance with the provisions of the 2016 revised Implementing Rules and Regulations (IRR) of Republic Act (RA) No. 9184.

The PBDs are intended as a model for admeasurements (unit prices or unit rates in a bill of quantities) types of contract, which are the most common in Works contracting.

The Bidding Documents shall clearly and adequately define, among others: (i) the objectives, scope, and expected outputs and/or results of the proposed contract; (ii) the eligibility requirements of Bidders; (iii) the expected contract duration; and (iv) the obligations, duties, and/or functions of the winning Bidder.

Care should be taken to check the relevance of the provisions of the PBDs against the requirements of the specific Works to be procured. If duplication of a subject is inevitable in other sections of the document prepared by the Procuring Entity, care must be exercised to avoid contradictions between clauses dealing with the same matter.

Moreover, each section is prepared with notes intended only as information for the Procuring Entity or the person drafting the Bidding Documents. They shall not be included in the final documents. The following general directions should be observed when using the documents:

- a. All the documents listed in the Table of Contents are normally required for the procurement of Infrastructure Projects. However, they should be adapted as necessary to the circumstances of the particular Project.
- b. Specific details, such as the “*name of the Procuring Entity*” and “*address for bid submission*,” should be furnished in the Instructions to Bidders, Bid Data Sheet, and Special Conditions of Contract. The final documents should contain neither blank spaces nor options.
- c. This Preface and the footnotes or notes in italics included in the Invitation to Bid, BDS, General Conditions of Contract, Special Conditions of Contract, Specifications, Drawings, and Bill of Quantities are not part of the text of the final document, although they contain instructions that the Procuring Entity should strictly follow.
- d. The cover should be modified as required to identify the Bidding Documents as to the names of the Project, Contract, and Procuring Entity, in addition to date of issue.

- e. Modifications for specific Procurement Project details should be provided in the Special Conditions of Contract as amendments to the Conditions of Contract. For easy completion, whenever reference has to be made to specific clauses in the Bid Data Sheet or Special Conditions of Contract, these terms shall be printed in bold typeface on Sections I (Instructions to Bidders) and III (General Conditions of Contract), respectively.
- f. For guidelines on the use of Bidding Forms and the procurement of Foreign-Assisted Projects, these will be covered by a separate issuance of the Government Procurement Policy Board.

TABLE OF CONTENTS

Glossary of Terms, Abbreviations, and Acronyms.....	5
Section I. Invitation to Bid	8
Section II. Instructions to Bidders.....	11
1. Scope of Bid.....	12
2. Funding Information	12
3. Bidding Requirements.....	12
4. Corrupt, Fraudulent, Collusive, Coercive, and Obstructive Practices	12
5. Eligible Bidders.....	13
6. Origin of Associated Goods	13
7. Subcontracts	13
8. Pre-Bid Conference.....	14
9. Clarification and Amendment of Bidding Documents.....	14
10. Documents Comprising the Bid: Eligibility and Technical Components.....	14
11. Documents Comprising the Bid: Financial Component	15
12. Alternative Bids	15
13. Bid Prices	15
14. Bid and Payment Currencies.....	15
15. Bid Security.....	16
16. Sealing and Marking of Bids.....	16
17. Deadline for Submission of Bids	16
18. Opening and Preliminary Examination of Bids	16
19. Detailed Evaluation and Comparison of Bids.....	17
20. Post Qualification.....	17
21. Signing of the Contract	17
Section III. Bid Data Sheet.....	18
Section IV. General Conditions of Contract	22
1. Scope of Contract.....	23
2. Sectional Completion of Works	23
3. Possession of Site.....	23
4. The Contractor’s Obligations.....	23
5. Performance Security	24
6. Site Investigation Reports	24

7.	Warranty.....	24
8.	Liability of the Contractor.....	24
9.	Termination for Other Causes.....	24
10.	Dayworks.....	25
11.	Program of Work.....	25
12.	Instructions, Inspections and Audits.....	25
13.	Advance Payment.....	25
14.	Progress Payments.....	25
15.	Operating and Maintenance Manuals.....	26
	Section V. Special Conditions of Contract.....	27
	Section VI. Specifications.....	30
	Section VII. Drawings.....	31
	Section VIII. Bill of Quantities.....	31
	Section IX. Checklist of Technical and Financial Documents.....	40

Glossary of Terms, Abbreviations, and Acronyms

ABC – Approved Budget for the Contract.

ARCC – Allowable Range of Contract Cost.

BAC – Bids and Awards Committee.

Bid – A signed offer or proposal to undertake a contract submitted by a bidder in response to and in consonance with the requirements of the bidding documents. Also referred to as *Proposal* and *Tender*. (2016 revised IRR, Section 5[c])

Bidder – Refers to a contractor, manufacturer, supplier, distributor and/or consultant who submits a bid in response to the requirements of the Bidding Documents. (2016 revised IRR, Section 5[d])

Bidding Documents – The documents issued by the Procuring Entity as the bases for bids, furnishing all information necessary for a prospective bidder to prepare a bid for the Goods, Infrastructure Projects, and/or Consulting Services required by the Procuring Entity. (2016 revised IRR, Section 5[e])

BIR – Bureau of Internal Revenue.

BSP – Bangko Sentral ng Pilipinas.

CDA – Cooperative Development Authority.

Consulting Services – Refer to services for Infrastructure Projects and other types of projects or activities of the GOP requiring adequate external technical and professional expertise that are beyond the capability and/or capacity of the GOP to undertake such as, but not limited to: (i) advisory and review services; (ii) pre-investment or feasibility studies; (iii) design; (iv) construction supervision; (v) management and related services; and (vi) other technical services or special studies. (2016 revised IRR, Section 5[i])

Contract – Refers to the agreement entered into between the Procuring Entity and the Supplier or Manufacturer or Distributor or Service Provider for procurement of Goods and Services; Contractor for Procurement of Infrastructure Projects; or Consultant or Consulting Firm for Procurement of Consulting Services; as the case may be, as recorded in the Contract Form signed by the parties, including all attachments and appendices thereto and all documents incorporated by reference therein.

Contractor – is a natural or juridical entity whose proposal was accepted by the Procuring Entity and to whom the Contract to execute the Work was awarded. Contractor as used in these Bidding Documents may likewise refer to a supplier, distributor, manufacturer, or consultant.

CPI – Consumer Price Index.

DOLE – Department of Labor and Employment.

DTI – Department of Trade and Industry.

Foreign-funded Procurement or Foreign-Assisted Project – Refers to procurement whose funding source is from a foreign government, foreign or international financing institution as specified in the Treaty or International or Executive Agreement. (2016 revised IRR, Section 5[b]).

GFI – Government Financial Institution.

GOCC – Government-owned and/or –controlled corporation.

Goods – Refer to all items, supplies, materials and general support services, except Consulting Services and Infrastructure Projects, which may be needed in the transaction of public businesses or in the pursuit of any government undertaking, project or activity, whether in the nature of equipment, furniture, stationery, materials for construction, or personal property of any kind, including non-personal or contractual services such as the repair and maintenance of equipment and furniture, as well as trucking, hauling, janitorial, security, and related or analogous services, as well as procurement of materials and supplies provided by the Procuring Entity for such services. The term “related” or “analogous services” shall include, but is not limited to, lease or purchase of office space, media advertisements, health maintenance services, and other services essential to the operation of the Procuring Entity. (2016 revised IRR, Section 5[r])

GOP – Government of the Philippines.

Infrastructure Projects – Include the construction, improvement, rehabilitation, demolition, repair, restoration or maintenance of roads and bridges, railways, airports, seaports, communication facilities, civil works components of information technology projects, irrigation, flood control and drainage, water supply, sanitation, sewerage and solid waste management systems, shore protection, energy/power and electrification facilities, national buildings, school buildings, hospital buildings, and other related construction projects of the government. Also referred to as *civil works or works*. (2016 revised IRR, Section 5[u])

LGUs – Local Government Units.

NFCC – Net Financial Contracting Capacity.

NGA – National Government Agency.

PCAB – Philippine Contractors Accreditation Board.

PhilGEPS - Philippine Government Electronic Procurement System.

Procurement Project – refers to a specific or identified procurement covering goods, infrastructure project or consulting services. A Procurement Project shall be described, detailed, and scheduled in the Project Procurement Management Plan prepared by the agency which shall be consolidated in the procuring entity's Annual Procurement Plan. (GPPB Circular No. 06-2019 dated 17 July 2019)

PSA – Philippine Statistics Authority.

SEC – Securities and Exchange Commission.

SLCC – Single Largest Completed Contract.

UN – United Nations.

Section I. Invitation to Bid



Republic of the Philippines
SOUTHERN LEYTE STATE UNIVERSITY
Main Campus, Sogod, Southern Leyte
website: www.slsuonline.edu.ph
email: slsumaincampus@gmail.com/
op@slsuonline.edu.ph telefax: (053) 577-8299



INVITATION TO BID

REHABILITATION OF FISH POND WITH ADVANCED POND FACILITIES IN SLSU BONTOC CAMPUS (EARLY PROCUREMENT ACTIVITY)

1. The Southern Leyte State University, through the **General Appropriations Act FY 2022** intends to apply the sum of **Fourteen Million Eight Hundred Forty Four Thousand Twenty Two Pesos and 32/100 only (₱14,844,022.32)** being the Approved Budget for the Contract (ABC) for the **Rehabilitation of Fish Pond with Advanced Pond Facilities in SLSU Bontoc Campus**. Bids received in excess of the ABC shall be automatically rejected at bid opening. Bids received in excess of the ABC shall be automatically rejected at bid opening.
2. The Southern Leyte State University now invites interested Bidders to apply for eligibility and to bid for the **Rehabilitation of Fish Pond with Advanced Pond Facilities in SLSU Bontoc Campus**. Completion of the Works required is within **Two Hundred (200) calendar days**. Bidders should have completed a contract similar to the Project. The description of an eligible bidder is contained in the Bidding Documents, particularly, in Section II (Instructions to Bidders).
3. Bidding will be conducted through open competitive bidding procedures using non-discretionary “pass/fail” criterion as specified in the 2016 revised Implementing Rules and Regulations (IRR) of Republic Act (RA) No. 9184.
4. Interested bidders may obtain further information from Southern Leyte State University Main Campus and inspect the Bidding Documents at the address given below from 8:00am-5:00pm.
5. A complete set of Bidding Documents may be acquired by interested bidders on **09 December, 2021** from given address and website/s below upon payment of the applicable fee for the Bidding Documents, pursuant to *the latest Guidelines issued by the GPPB, in the amount of Fifteen Thousand Pesos (₱15,000.00)*. The Procuring Entity shall allow the bidder to present its proof of payment for the fees by submitting a copy of the Official Receipt either in person, by facsimile, or through electronic means to the BAC Secretariat.
6. The Southern Leyte State University will hold a Pre-Bid Conference on **17 December 2021 at 10:30 in the morning** through videoconferencing/webcasting via **Zoom** which shall be open to all interested bidders.

Meeting ID: **850 0582 3050**

Passcode: **482431**

7. Bids must be duly received by the BAC Secretariat through manual submission at the office address as indicated below, on or before **10:30 in the morning of 29 December 2021**. Late bids shall not be accepted.

8. All bids must be accompanied by a bid security in any of the acceptable forms and in the amount stated in ITB Clause 15.
9. Bid opening shall be on **29 December 2021**, at **10:30 in the morning** at the **Plenary Hall, USSC Building, SLSU Main Campus, Sogod, Southern Leyte** and/or via videoconferencing/webcasting via **Zoom**. Link will be provided later.
10. The Southern Leyte State University reserves the right to accept or reject any bid, to annul the bidding process, and to reject all bids at any time prior to contract award, without thereby incurring any liability to the affected bidder or bidders and to make an award to the bidder whose proposal is deemed most advantageous to the government.
11. Other necessary information deemed relevant by the Procuring Entity

SLSU's Health and Safety Protocols in Procurement
To avoid transmission of COVID-19, the University Bids & Awards Committee will observe strict health protocols at all times and as we shift to the new normal work guidelines, we will adapt new measures on procurement activities of the university.
<p>Purchasing of Bid Documents:</p> <p>Bidders are encouraged to purchase through SLSU Bank Account (Land Bank of the Philippines)</p> <p style="text-align: center;">Account Name: SLSU Sogod, LBP Trust Account Account Number: 3322109503</p>
<p>Pre-Bid Conference</p> <ol style="list-style-type: none"> 1. Pre-bid Conference will be done through videoconferencing. 2. All interested bidders must send their clarifications and queries through email which will be answered through bid bulletin to be posted in PhilGEPS and SLSU website.
<p>Opening and Submission of Bids</p> <ol style="list-style-type: none"> 1. SLSU will still require manual submission of bid tenders. 2. The bidder must submit its bid on time with proper labeling or sealing. 3. Bidders may participate virtually and watch the activity through videoconferencing via Zoom.

12. For further information, please refer to:

BAC Secretariat
 Ground Floor, CCSIT Building
 SLSU Main Campus, Sogod, Southern Leyte
 E-mail address: bac_sg@southernleytestateu.edu.ph
 Contact Nos. 09565490615 / 09078309506

13. You may visit the following website to download the Bidding Documents: www.slsuonline.edu.ph

07 December 2021

Date of Issue

Sgd.
MABEL R. CALVA
 UBAC Chairperson

Section II. Instructions to Bidders

1. Scope of Bid

The Procuring Entity, *SLSU Main Campus* invites Bids for the ***Rehabilitation of Fishpond with Advanced Pond Facilities***, with Project Identification Number ***PB EPA 2022-IP-02***.

[Note: The Project Identification Number is assigned by the Procuring Entity based on its own coding scheme and is not the same as the PhilGEPS reference number, which is generated after the posting of the bid opportunity on the PhilGEPS website.]

The Procurement Project (referred to herein as “Project”) is for the construction of Works, as described in Section VI (Specifications).

2. Funding Information

2.1. The GOP through the source of funding as indicated below for **2022** in the amount of ***Fourteen Million Eight Hundred Forty Four Thousand Twenty Two Pesos and 32/100 only (₱14,844,022.32)***.

2.2. The source of funding is:

a. GAA FY 2022

3. Bidding Requirements

The Bidding for the Project shall be governed by all the provisions of RA No. 9184 and its 2016 revised IRR, including its Generic Procurement Manual and associated policies, rules and regulations as the primary source thereof, while the herein clauses shall serve as the secondary source thereof.

Any amendments made to the IRR and other GPPB issuances shall be applicable only to the ongoing posting, advertisement, or invitation to bid by the BAC through the issuance of a supplemental or bid bulletin.

The Bidder, by the act of submitting its Bid, shall be deemed to have inspected the site, determined the general characteristics of the contracted Works and the conditions for this Project, such as the location and the nature of the work; (b) climatic conditions; (c) transportation facilities; (c) nature and condition of the terrain, geological conditions at the site communication facilities, requirements, location and availability of construction aggregates and other materials, labor, water, electric power and access roads; and (d) other factors that may affect the cost, duration and execution or implementation of the contract, project, or work and examine all instructions, forms, terms, and project requirements in the Bidding Documents.

4. Corrupt, Fraudulent, Collusive, Coercive, and Obstructive Practices

The Procuring Entity, as well as the Bidders and Contractors, shall observe the highest standard of ethics during the procurement and execution of the contract. They or

through an agent shall not engage in corrupt, fraudulent, collusive, coercive, and obstructive practices defined under Annex “I” of the 2016 revised IRR of RA No. 9184 or other integrity violations in competing for the Project.

5. Eligible Bidders

- 5.1. Only Bids of Bidders found to be legally, technically, and financially capable will be evaluated.
- 5.2. The Bidder must have an experience of having completed a Single Largest Completed Contract (SLCC) that is similar to this Project, equivalent to at least fifty percent (50%) of the ABC adjusted, if necessary, by the Bidder to current prices using the PSA’s CPI, except under conditions provided for in Section 23.4.2.4 of the 2016 revised IRR of RA No. 9184.

A contract is considered to be “similar” to the contract to be bid if it has the major categories of work stated in the **BDS**.

- 5.3. For Foreign-funded Procurement, the Procuring Entity and the foreign government/foreign or international financing institution may agree on another track record requirement, as specified in the Bidding Document prepared for this purpose.
- 5.4. The Bidders shall comply with the eligibility criteria under Section 23.4.2 of the 2016 IRR of RA No. 9184.

6. Origin of Associated Goods

There is no restriction on the origin of Goods other than those prohibited by a decision of the UN Security Council taken under Chapter VII of the Charter of the UN.

7. Subcontracts

- 7.1. The Bidder may subcontract portions of the Project to the extent allowed by the Procuring Entity as stated herein, but in no case more than fifty percent (50%) of the Project.

The Procuring Entity has prescribed that:

- a. ***Subcontracting is not allowed.***

- 7.1. *[If Procuring Entity has determined that subcontracting is allowed during the bidding, state:]* The Bidder must submit together with its Bid the documentary requirements of the subcontractor(s) complying with the eligibility criteria stated in **ITB** Clause 5 in accordance with Section 23.4 of the 2016 revised IRR of RA No. 9184 pursuant to Section 23.1 thereof.

- 7.2. *[If subcontracting is allowed during the contract implementation stage, state:]*
The Supplier may identify its subcontractor during the contract implementation stage. Subcontractors identified during the bidding may be changed during the implementation of this Contract. Subcontractors must submit the documentary requirements under Section 23.1 of the 2016 revised IRR of RA No. 9184 and comply with the eligibility criteria specified in **ITB** Clause 5 to the implementing or end-user unit.
- 7.3. Subcontracting of any portion of the Project does not relieve the Contractor of any liability or obligation under the Contract. The Supplier will be responsible for the acts, defaults, and negligence of any subcontractor, its agents, servants, or workmen as fully as if these were the Contractor's own acts, defaults, or negligence, or those of its agents, servants, or workmen.

8. Pre-Bid Conference

The Procuring Entity will hold a pre-bid conference for this Project on the specified date and time and either at its physical address *{[insert if applicable]}* and/or through videoconferencing/webcasting} as indicated in paragraph 6 of the **IB**.

9. Clarification and Amendment of Bidding Documents

Prospective bidders may request for clarification on and/or interpretation of any part of the Bidding Documents. Such requests must be in writing and received by the Procuring Entity, either at its given address or through electronic mail indicated in the **IB**, at least ten (10) calendar days before the deadline set for the submission and receipt of Bids.

10. Documents Comprising the Bid: Eligibility and Technical Components

- 10.1. The first envelope shall contain the eligibility and technical documents of the Bid as specified in **Section IX. Checklist of Technical and Financial Documents**.
- 10.2. If the eligibility requirements or statements, the bids, and all other documents for submission to the BAC are in foreign language other than English, it must be accompanied by a translation in English, which shall be authenticated by the appropriate Philippine foreign service establishment, post, or the equivalent office having jurisdiction over the foreign bidder's affairs in the Philippines. For Contracting Parties to the Apostille Convention, only the translated documents shall be authenticated through an apostille pursuant to GPPB Resolution No. 13-2019 dated 23 May 2019. The English translation shall govern, for purposes of interpretation of the bid.
- 10.3. A valid PCAB License is required, and in case of joint ventures, a valid special PCAB License, and registration for the type and cost of the contract for this Project. Any additional type of Contractor license or permit shall be indicated in the **BDS**.

- 10.4. A List of Contractor's key personnel (e.g., Project Manager, Project Engineers, Materials Engineers, and Foremen) assigned to the contract to be bid, with their complete qualification and experience data shall be provided. These key personnel must meet the required minimum years of experience set in the **BDS**.
- 10.5. A List of Contractor's major equipment units, which are owned, leased, and/or under purchase agreements, supported by proof of ownership, certification of availability of equipment from the equipment lessor/vendor for the duration of the project, as the case may be, must meet the minimum requirements for the contract set in the **BDS**.

11. Documents Comprising the Bid: Financial Component

- 11.1. The second bid envelope shall contain the financial documents for the Bid as specified in **Section IX. Checklist of Technical and Financial Documents**.
- 11.2. Any bid exceeding the ABC indicated in paragraph 1 of the **IB** shall not be accepted.
- 11.3. For Foreign-funded procurement, a ceiling may be applied to bid prices provided the conditions are met under Section 31.2 of the 2016 revised IRR of RA No. 9184.

12. Alternative Bids

Bidders shall submit offers that comply with the requirements of the Bidding Documents, including the basic technical design as indicated in the drawings and specifications. Unless there is a value engineering clause in the **BDS**, alternative Bids shall not be accepted.

13. Bid Prices

All bid prices for the given scope of work in the Project as awarded shall be considered as fixed prices, and therefore not subject to price escalation during contract implementation, except under extraordinary circumstances as determined by the NEDA and approved by the GPPB pursuant to the revised Guidelines for Contract Price Escalation guidelines.

14. Bid and Payment Currencies

- 14.1. Bid prices may be quoted in the local currency or tradeable currency accepted by the BSP at the discretion of the Bidder. However, for purposes of bid evaluation, Bids denominated in foreign currencies shall be converted to Philippine currency based on the exchange rate as published in the BSP reference rate bulletin on the day of the bid opening.

14.2. *Payment of the contract price shall be made in:*

- a. Philippine Pesos.

15. Bid Security

15.1. The Bidder shall submit a Bid Securing Declaration or any form of Bid Security in the amount indicated in the **BDS**, which shall be not less than the percentage of the ABC in accordance with the schedule in the **BDS**.

15.2. The Bid and bid security shall be valid until **27 April 2022**. Any bid not accompanied by an acceptable bid security shall be rejected by the Procuring Entity as non-responsive.

16. Sealing and Marking of Bids

Each Bidder shall submit one copy of the first and second components of its Bid.

The Procuring Entity may request additional hard copies and/or electronic copies of the Bid. However, failure of the Bidders to comply with the said request shall not be a ground for disqualification.

If the Procuring Entity allows the submission of bids through online submission to the given website or any other electronic means, the Bidder shall submit an electronic copy of its Bid, which must be digitally signed. An electronic copy that cannot be opened or is corrupted shall be considered non-responsive and, thus, automatically disqualified.

17. Deadline for Submission of Bids

The Bidders shall submit on the specified date and time and either at its physical address or through online submission as indicated in paragraph 7 of the **IB**.

18. Opening and Preliminary Examination of Bids

18.1. The BAC shall open the Bids in public at the time, on the date, and at the place specified in paragraph 9 of the **IB**. The Bidders' representatives who are present shall sign a register evidencing their attendance. In case videoconferencing, webcasting or other similar technologies will be used, attendance of participants shall likewise be recorded by the BAC Secretariat.

In case the Bids cannot be opened as scheduled due to justifiable reasons, the rescheduling requirements under Section 29 of the 2016 revised IRR of RA No. 9184 shall prevail.

18.2. The preliminary examination of Bids shall be governed by Section 30 of the 2016 revised IRR of RA No. 9184.

19. Detailed Evaluation and Comparison of Bids

- 19.1. The Procuring Entity's BAC shall immediately conduct a detailed evaluation of all Bids rated "*passed*" using non-discretionary pass/fail criteria. The BAC shall consider the conditions in the evaluation of Bids under Section 32.2 of 2016 revised IRR of RA No. 9184.
- 19.2. If the Project allows partial bids, all Bids and combinations of Bids as indicated in the **BDS** shall be received by the same deadline and opened and evaluated simultaneously so as to determine the Bid or combination of Bids offering the lowest calculated cost to the Procuring Entity. Bid Security as required by **ITB** Clause 16 shall be submitted for each contract (lot) separately.
- 19.3. In all cases, the NFCC computation pursuant to Section 23.4.2.6 of the 2016 revised IRR of RA No. 9184 must be sufficient for the total of the ABCs for all the lots participated in by the prospective Bidder.

20. Post Qualification

Within a non-extendible period of five (5) calendar days from receipt by the Bidder of the notice from the BAC that it submitted the Lowest Calculated Bid, the Bidder shall submit its latest income and business tax returns filed and paid through the BIR Electronic Filing and Payment System (eFPS), and other appropriate licenses and permits required by law and stated in the **BDS**.

21. Signing of the Contract

The documents required in Section 37.2 of the 2016 revised IRR of RA No. 9184 shall form part of the Contract. Additional Contract documents are indicated in the **BDS**.

Section III. Bid Data Sheet

Bid Data Sheet

ITB Clause																															
5.2	For this purpose, contracts similar to the Project refer to contracts which have the same major categories of work, which shall be: <i>Rehabilitation of Fishpond with Advanced Pond Facilities.</i>																														
7.1	<i>Sub-contracting is not allowed.</i>																														
10.3	<i>[Specify if another Contractor license or permit is required.]</i>																														
10.4	<p>The key personnel must meet the required minimum years of experience set below:</p> <table style="width: 100%; border-collapse: collapse;"> <thead> <tr> <th style="text-align: left;"><u>Key Personnel</u></th> <th style="text-align: left;"><u>General Experience</u></th> <th style="text-align: left;"><u>Relevant Experience</u></th> </tr> </thead> <tbody> <tr> <td style="text-align: center;">Key Personnel</td> <td style="text-align: center;">No. of Persons</td> <td style="text-align: center;">Minimum Experience</td> </tr> <tr> <td>Project Manager</td> <td style="text-align: center;">1</td> <td style="text-align: center;">3 years</td> </tr> <tr> <td>Project Engineer</td> <td style="text-align: center;">1</td> <td style="text-align: center;">3 years</td> </tr> <tr> <td>Foreman</td> <td style="text-align: center;">1</td> <td style="text-align: center;">3 years</td> </tr> <tr> <td>Leadman</td> <td style="text-align: center;">1</td> <td style="text-align: center;">3 years</td> </tr> </tbody> </table>	<u>Key Personnel</u>	<u>General Experience</u>	<u>Relevant Experience</u>	Key Personnel	No. of Persons	Minimum Experience	Project Manager	1	3 years	Project Engineer	1	3 years	Foreman	1	3 years	Leadman	1	3 years												
<u>Key Personnel</u>	<u>General Experience</u>	<u>Relevant Experience</u>																													
Key Personnel	No. of Persons	Minimum Experience																													
Project Manager	1	3 years																													
Project Engineer	1	3 years																													
Foreman	1	3 years																													
Leadman	1	3 years																													
10.5	<p>The minimum major equipment requirements are the following:</p> <table style="width: 100%; border-collapse: collapse;"> <thead> <tr> <th style="text-align: left;">Equipment</th> <th style="text-align: left;">Capacity</th> <th style="text-align: left;">No. of Units</th> </tr> </thead> <tbody> <tr> <td>Transit Mixer</td> <td></td> <td style="text-align: center;">0</td> </tr> <tr> <td>Concrete Mixer</td> <td style="text-align: center;">one bagger</td> <td style="text-align: center;">1</td> </tr> <tr> <td>Concrete Vibrator</td> <td></td> <td style="text-align: center;">1</td> </tr> <tr> <td>Welding Machine</td> <td style="text-align: center;">300 A</td> <td style="text-align: center;">2</td> </tr> <tr> <td>Backhoe</td> <td></td> <td style="text-align: center;">1</td> </tr> <tr> <td>Cut-off Machine</td> <td></td> <td style="text-align: center;">1</td> </tr> <tr> <td>Dumptruck</td> <td style="text-align: center;">3 cu.m cap</td> <td style="text-align: center;">1</td> </tr> <tr> <td>Power Tools</td> <td></td> <td style="text-align: center;">1</td> </tr> <tr> <td>Minor Tools</td> <td></td> <td style="text-align: center;">1</td> </tr> </tbody> </table>	Equipment	Capacity	No. of Units	Transit Mixer		0	Concrete Mixer	one bagger	1	Concrete Vibrator		1	Welding Machine	300 A	2	Backhoe		1	Cut-off Machine		1	Dumptruck	3 cu.m cap	1	Power Tools		1	Minor Tools		1
Equipment	Capacity	No. of Units																													
Transit Mixer		0																													
Concrete Mixer	one bagger	1																													
Concrete Vibrator		1																													
Welding Machine	300 A	2																													
Backhoe		1																													
Cut-off Machine		1																													
Dumptruck	3 cu.m cap	1																													
Power Tools		1																													
Minor Tools		1																													
12.1(a)(iii)	Bidders must submit the following:																														
	<p>1. Duly signed <i>Statement of all Ongoing Government and Private Construction Contracts including contracts awarded but not yet started (SF-INFR-15).</i></p> <ul style="list-style-type: none"> • <i>The supporting documents stated in the said form shall be submitted during the opening of bids.</i> 																														
	<p>2. Duly signed <i>Statement showing the bidder's Single Largest Completed Contract which is similar in nature (SF-INFR-16).</i></p> <ul style="list-style-type: none"> • <i>The foregoing supporting documents shall be submitted during opening of bids.</i> 																														
12.1(a)(iv)	The PCAB Registration for this project is Small B for General Building. For Joint Venture bidders, a Joint License issued by the PCAB pursuant to Section 38 of RA 4566, and not the PCAB license and registration individually issued																														

	to each joint venture partner must be submitted. Failure of the joint venture bidder to submit a Joint Venture License may be a ground for its disqualification despite the submission of the individual licenses of each joint venture partner.																																													
12.1(b)(ii)(ii.2)	<p>Duly signed List of Contractors Personnel to be signed to the contract to be bid with their complete qualification and experience data as follows:</p> <table border="1"> <thead> <tr> <th></th> <th>No. of Persons</th> <th>Minimum Experience</th> </tr> </thead> <tbody> <tr> <td>Project Manager</td> <td>1</td> <td>3 years</td> </tr> <tr> <td>Project Engineer</td> <td>1</td> <td>3 years</td> </tr> <tr> <td>Foreman</td> <td>1</td> <td>3 years</td> </tr> <tr> <td>Leadman</td> <td>1</td> <td>3 years</td> </tr> </tbody> </table> <p>Duly signed Statement of Availability of Key Personnel and Equipment (SF-INFR-18). The minimum major equipment requirements are the following:</p> <table border="1"> <thead> <tr> <th>Equipment</th> <th>Capacity</th> <th>No. of Units</th> </tr> </thead> <tbody> <tr> <td>Transit Mixer</td> <td></td> <td>0</td> </tr> <tr> <td>Concrete Mixer</td> <td>one bagger</td> <td>1</td> </tr> <tr> <td>Concrete Vibrator</td> <td></td> <td>1</td> </tr> <tr> <td>Welding Machine</td> <td>300 A</td> <td>2</td> </tr> <tr> <td>Backhoe</td> <td></td> <td>1</td> </tr> <tr> <td>Cut-off Machine</td> <td></td> <td>1</td> </tr> <tr> <td>Dumptruck</td> <td>3 cu.m cap</td> <td>1</td> </tr> <tr> <td>Power Tools</td> <td></td> <td>1</td> </tr> <tr> <td>Minor Tools</td> <td></td> <td>1</td> </tr> </tbody> </table>		No. of Persons	Minimum Experience	Project Manager	1	3 years	Project Engineer	1	3 years	Foreman	1	3 years	Leadman	1	3 years	Equipment	Capacity	No. of Units	Transit Mixer		0	Concrete Mixer	one bagger	1	Concrete Vibrator		1	Welding Machine	300 A	2	Backhoe		1	Cut-off Machine		1	Dumptruck	3 cu.m cap	1	Power Tools		1	Minor Tools		1
	No. of Persons	Minimum Experience																																												
Project Manager	1	3 years																																												
Project Engineer	1	3 years																																												
Foreman	1	3 years																																												
Leadman	1	3 years																																												
Equipment	Capacity	No. of Units																																												
Transit Mixer		0																																												
Concrete Mixer	one bagger	1																																												
Concrete Vibrator		1																																												
Welding Machine	300 A	2																																												
Backhoe		1																																												
Cut-off Machine		1																																												
Dumptruck	3 cu.m cap	1																																												
Power Tools		1																																												
Minor Tools		1																																												
12.1(b)(ii)(ii.4)	Duly signed List of Contractors Equipment OWNED/LEASED (pls. see Invitation to Bid), assigned to the Proposed Contract (SF-INFR-49).																																													
	Original duly signed Omnibus Sworn Statement (OSS) and if applicable, Original Notarized Secretary's Certificate in case of a corporation, partnership, or cooperative; or Original Special Power of Attorney of all members of the joint venture giving full power and authority to its officer to sign the OSS and do acts to represent the bidder.																																													
15.1	<p>The bid security shall be in the form of a Bid Securing Declaration or any of the following forms and amounts:</p> <ol style="list-style-type: none"> The amount of not less than ₱296,880.45 [Insert two percent (2%) of ABC], if bid security is in cash, cashier's/manager's check, bank draft/guarantee or irrevocable letter of credit; The amount of not less than ₱742,201.12 [Insert five percent (5%) of ABC] if bid security is in Surety Bond. 																																													
19.2	Partial Bids are not allowed.																																													
20	<p>Certification from:</p> <ul style="list-style-type: none"> DENR-Mines & Geosciences Bureau 																																													

	<ul style="list-style-type: none"> • <i>DPWH Southern Leyte District engineering Office</i>
21	<p>Additional contract documents relevant to the Project that may be required by existing laws and/or the Procuring Entity, such as construction schedule and S-curve, manpower schedule, construction methods, equipment utilization schedule, construction safety and health program approved by the DOLE, and other acceptable tools of project scheduling.</p> <ul style="list-style-type: none"> • Organizational Chart for the contract to bid; • Duly signed Bio-Data of Contractor's Key Personnel. • Duly notarized Affidavit of Commitment from the bidder's Key Personnel • Duly signed Construction Schedule, S-Curve and PERT-CPM Network Diagram; • Duly signed Manpower Schedule • Duly signed Construction Method in narrative form • Certification of Site Inspection issued by the Manager or his authorized representative • Construction safety and health program approved by DOLE

Section IV. General Conditions of Contract

1. Scope of Contract

This Contract shall include all such items, although not specifically mentioned, that can be reasonably inferred as being required for its completion as if such items were expressly mentioned herein. All the provisions of RA No. 9184 and its 2016 revised IRR, including the Generic Procurement Manual, and associated issuances, constitute the primary source for the terms and conditions of the Contract, and thus, applicable in contract implementation. Herein clauses shall serve as the secondary source for the terms and conditions of the Contract.

This is without prejudice to Sections 74.1 and 74.2 of the 2016 revised IRR of RA No. 9184 allowing the GPPB to amend the IRR, which shall be applied to all procurement activities, the advertisement, posting, or invitation of which were issued after the affectivity of the said amendment.

2. Sectional Completion of Works

If sectional completion is specified in the **Special Conditions of Contract (SCC)**, references in the Conditions of Contract to the Works, the Completion Date, and the Intended Completion Date shall apply to any Section of the Works (other than references to the Completion Date and Intended Completion Date for the whole of the Works).

3. Possession of Site

3.1 The Procuring Entity shall give possession of all or parts of the Site to the Contractor based on the schedule of delivery indicated in the **SCC**, which corresponds to the execution of the Works. If the Contractor suffers delay or incurs cost from failure on the part of the Procuring Entity to give possession in accordance with the terms of this clause, the Procuring Entity's Representative shall give the Contractor a Contract Time Extension and certify such sum as fair to cover the cost incurred, which sum shall be paid by Procuring Entity.

3.2 If possession of a portion is not given by the above date, the Procuring Entity will be deemed to have delayed the start of the relevant activities. The resulting adjustments in contract time to address such delay may be addressed through contract extension provided under Annex "E" of the 2016 revised IRR of RA No. 9184.

4. The Contractor's Obligations

The Contractor shall employ the key personnel named in the Schedule of Key Personnel indicating their designation, in accordance with **ITB** Clause 10.3 and specified in the **BDS**, to carry out the supervision of the Works.

The Procuring Entity will approve any proposed replacement of key personnel only if their relevant qualifications and abilities are equal to or better than those of the personnel listed in the Schedule.

5. Performance Security

5.1. Within ten (10) calendar days from receipt of the Notice of Award from the Procuring Entity but in no case later than the signing of the contract by both parties, the successful Bidder shall furnish the performance security in any of the forms prescribed in Section 39 of the 2016 revised IRR.

5.2. The Contractor, by entering into the Contract with the Procuring Entity, acknowledges the right of the Procuring Entity to institute action pursuant to RA No. 3688 against any subcontractor be they an individual, firm, partnership, corporation, or association supplying the Contractor with labor, materials and/or equipment for the performance of this Contract.

6. Site Investigation Reports

The Contractor, in preparing the Bid, shall rely on any Site Investigation Reports referred to in the SCC supplemented by any information obtained by the Contractor.

7. Warranty

7.1. In case the Contractor fails to undertake the repair works under Section 62.2.2 of the 2016 revised IRR, the Procuring Entity shall forfeit its performance security, subject its property(ies) to attachment or garnishment proceedings, and perpetually disqualify it from participating in any public bidding. All payables of the GOP in his favor shall be offset to recover the costs.

7.2. The warranty against Structural Defects/Failures, except that occasioned-on force majeure, shall cover the period from the date of issuance of the Certificate of Final Acceptance by the Procuring Entity. Specific duration of the warranty is found in the SCC.

8. Liability of the Contractor

Subject to additional provisions, if any, set forth in the SCC, the Contractor's liability under this Contract shall be as provided by the laws of the Republic of the Philippines.

If the Contractor is a joint venture, all partners to the joint venture shall be jointly and severally liable to the Procuring Entity.

9. Termination for Other Causes

Contract termination shall be initiated in case it is determined *prima facie* by the Procuring Entity that the Contractor has engaged, before, or during the implementation

of the contract, in unlawful deeds and behaviors relative to contract acquisition and implementation, such as, but not limited to corrupt, fraudulent, collusive, coercive, and obstructive practices as stated in **ITB** Clause 4.

10. Dayworks

Subject to the guidelines on Variation Order in Annex “E” of the 2016 revised IRR of RA No. 9184, and if applicable as indicated in the **SCC**, the Dayworks rates in the Contractor’s Bid shall be used for small additional amounts of work only when the Procuring Entity’s Representative has given written instructions in advance for additional work to be paid for in that way.

11. Program of Work

11.1. The Contractor shall submit to the Procuring Entity’s Representative for approval the said Program of Work showing the general methods, arrangements, order, and timing for all the activities in the Works. The submissions of the Program of Work are indicated in the **SCC**.

11.2. The Contractor shall submit to the Procuring Entity’s Representative for approval an updated Program of Work at intervals no longer than the period stated in the **SCC**. If the Contractor does not submit an updated Program of Work within this period, the Procuring Entity’s Representative may withhold the amount stated in the **SCC** from the next payment certificate and continue to withhold this amount until the next payment after the date on which the overdue Program of Work has been submitted.

12. Instructions, Inspections and Audits

The Contractor shall permit the GOP or the Procuring Entity to inspect the Contractor’s accounts and records relating to the performance of the Contractor and to have them audited by auditors of the GOP or the Procuring Entity, as may be required.

13. Advance Payment

The Procuring Entity shall, upon a written request of the Contractor which shall be submitted as a Contract document, make an advance payment to the Contractor in an amount not exceeding fifteen percent (15%) of the total contract price, to be made in lump sum, or at the most two installments according to a schedule specified in the **SCC**, subject to the requirements in Annex “E” of the 2016 revised IRR of RA No. 9184.

14. Progress Payments

The Contractor may submit a request for payment for Work accomplished. Such requests for payment shall be verified and certified by the Procuring Entity’s Representative/Project Engineer. Except as otherwise stipulated in the **SCC**, materials

and equipment delivered on the site but not completely put in place shall not be included for payment.

15. Operating and Maintenance Manuals

- 15.1. If required, the Contractor will provide “as built” Drawings and/or operating and maintenance manuals as specified in the **SCC**.
- 15.2. If the Contractor does not provide the Drawings and/or manuals by the dates stated above, or they do not receive the Procuring Entity’s Representative’s approval, the Procuring Entity’s Representative may withhold the amount stated in the **SCC** from payments due to the Contractor.

Section V. Special Conditions of Contract

Special Conditions of Contract

GCC Clause	
2	<i>“No sectional completion of work,”</i>
4.1	<i>The Procuring Entity shall give possession of all parts of the Site to the Contractor from the Notice to Proceed.</i>
6	The site investigation reports are: <i>[list here the required site investigation reports.]</i>
7.2	<p><i>[Select one, delete the other.]</i></p> <p><i>[In case of permanent structures, such as buildings of types 4 and 5 as classified under the National Building Code of the Philippines and other structures made of steel, iron, or concrete which comply with relevant structural codes (e.g., DPWH Standard Specifications), such as, but not limited to, steel/concrete bridges, flyovers, aircraft movement areas, ports, dams, tunnels, filtration and treatment plants, sewerage systems, power plants, transmission and communication towers, railway system, and other similar permanent structures:] Fifteen (15) years.</i></p> <p><i>[In case of semi-permanent structures, such as buildings of types 1, 2, and 3 as classified under the National Building Code of the Philippines, concrete/asphalt roads, concrete river control, drainage, irrigation lined canals, river landing, deep wells, rock causeway, pedestrian overpass, and other similar semi-permanent structures:] Five (5) years.</i></p> <p><i>[In case of other structures, such as bailey and wooden bridges, shallow wells, spring developments, and other similar structures:] Two (2) years.</i></p>
10	<p><i>[Select one, delete the other:]</i></p> <p style="padding-left: 40px;">a. Dayworks are applicable at the rate shown in the Contractor’s original Bid.</p> <p style="padding-left: 40px;">b. No dayworks are applicable to the contract.</p>
11.1	The Contractor shall submit the Program of Work to the Procuring Entity’s Representative within <i>[insert number]</i> days of delivery of the Notice of Award.
11.2	The amount to be withheld for late submission of an updated Program of Work is <i>[insert amount]</i> .
13	The amount of the advance payment is <i>[insert amount as percentage of the contract price that shall not exceed 15% of the total contract price and schedule of payment]</i> .
14	Materials and equipment delivered on the site but not completely put in place shall be included for payment.
15.1	The date by which operating and maintenance manuals are required is <i>[date]</i> .

	The date by which “as built” drawings are required is <i>Ten (10) calendar days upon completion of the project.</i>
15.2	No amount will be withheld for failing to produce “as built” drawings and/or operating and maintenance manuals within the date required. However, the approved As-Built Drawings shall form part of the requirements in processing the final Progress Billing payment.

Section VI. Specifications

Section VII. Drawings

ARCHITECTURAL PLANS

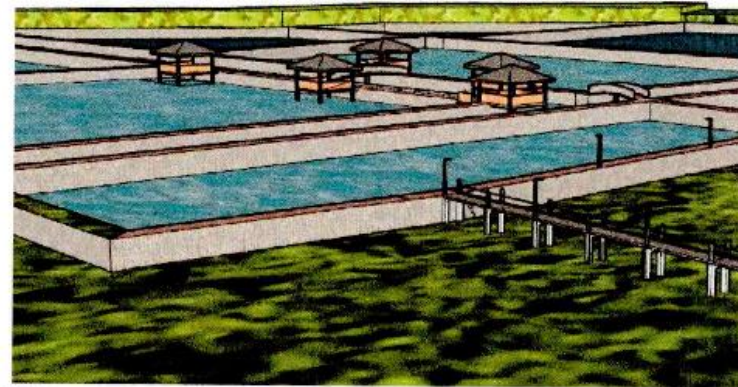
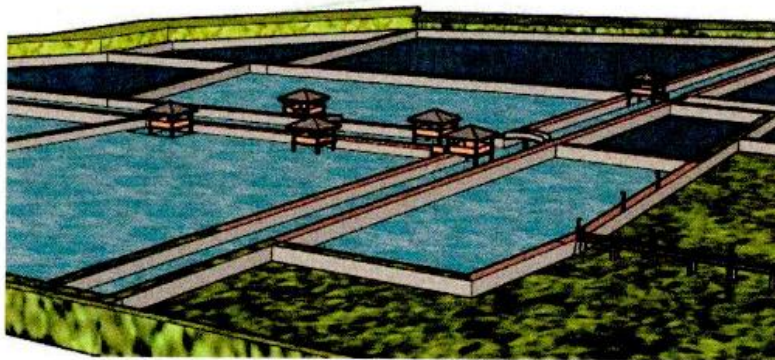



PERSPECTIVE

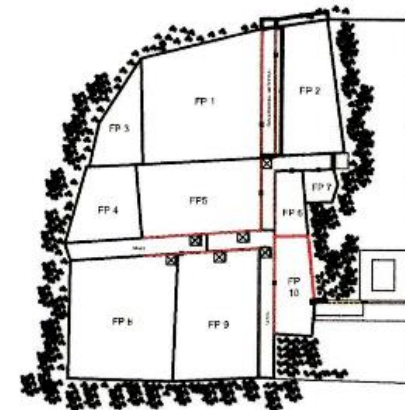

LOCATION MAP



SITE DEVELOPMENT PLAN



	PROJECT TITLE: REHABILITATION OF FISHPOND WITH ADVANCED FACILITIES SAN RAMON, BONTOC SOUTHERN LEYTE	ARCHITECT: JOHNE F. MAGNITE, uap	NOTED BY: JINKY F. LUMBRE PLANO-DESIGNATE	RECOMMENDING APPROVAL: GORDON B. OPINA HEAD, ADMINISTRATION	APPROVED BY: DEWOOOGEN P. BACLAYON, Ph.D CAMPUS DIRECTOR	SHEET CONTENTS: PERSPECTIVE LOCATION MAP	SHEET NO.: 
---	---	--	--	--	---	---	--



LEGEND:

- 1 - FOOT BRIDGE 1
- 2 - COTTAGE
- 3 - EXISTING BANGUS WATCH TOWER
- 4 - FOOT BRIDGE COLUMN WITH G.I. PIPE POST LAMP
- 5 - MAIN GATE
- 6 - CONCRETE BRICK PAVERS
- 7 - PROPOSED FISH PROCESSING PLANT
- 8 - FISH POND (FP)
- 9 - FOOT BRIDGE 2
- 10 - SECONDARY POND GATE
- 11 - MAIN CANAL

SITE DEVELOPMENT PLAN

OWNER	PROJECT TITLE	ARCHITECT	NOTED BY	RECOMMENDING APPROVAL	APPROVED BY	SHEET CONTENTS	SHEET NO.
	REHABILITATION OF FISHPOND WITH ADVANCED FACILITIES SAN RAMON BONTOC SOUTHERN LEYTE	JOANNE F. MAGLINTE, uap	JINKY F. LUMBRE POND DESIGNATE	GORDON B. OPINA HEAD, ADMINISTRATION	DEWOOWOOGEN P. BACLAYON, Ph.D CAMPUS DIRECTOR	FISHPOND REHAB PLAN	

STRUCTURAL PLANS

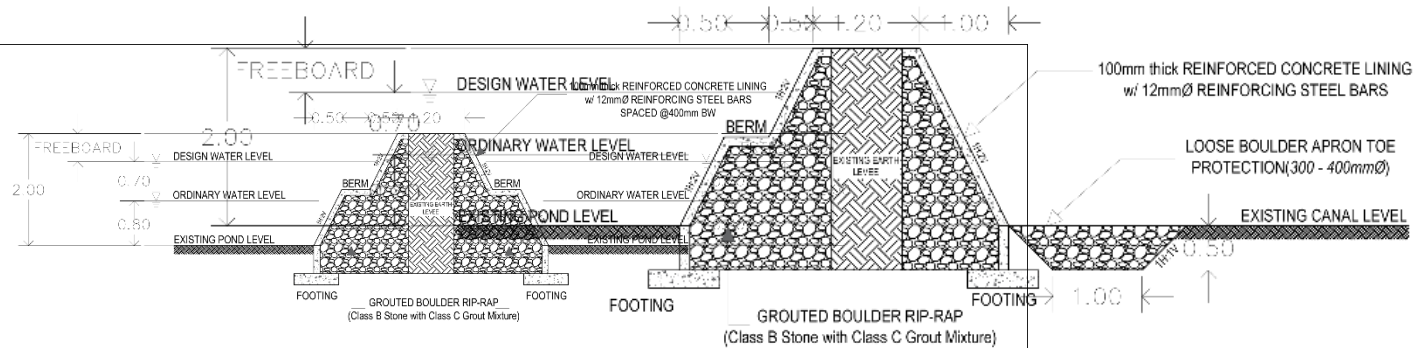

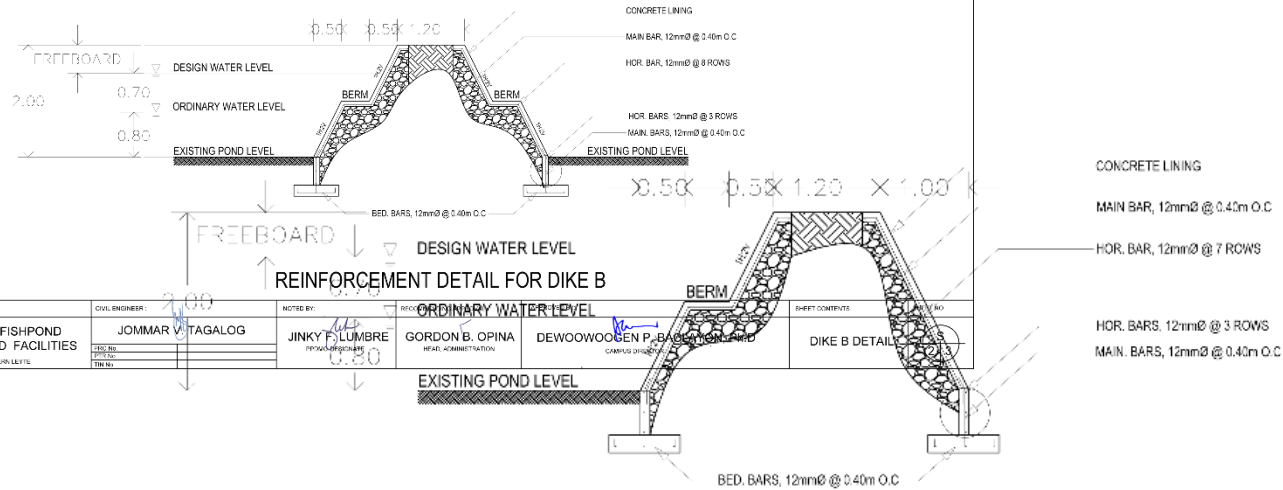

TRANSVERSE SECTION FOR DIKE B

TRANSVERSE SECTION FOR DIKE A



REINFORCEMENT DETAIL FOR DIKE A

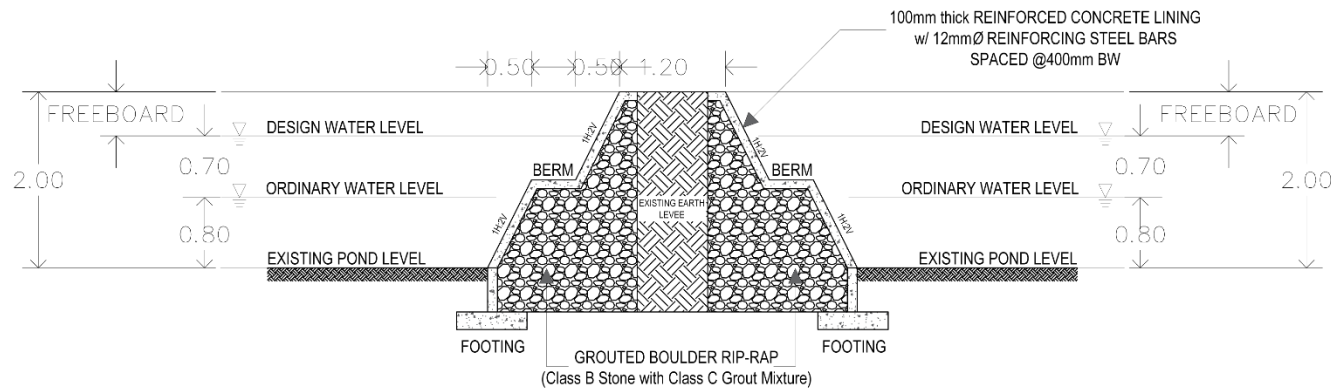

OWNER	PROJECT TITLE	CIVIL ENGINEER	NOTED BY	RECOMMENDING APPROVAL	APPROVED BY	SHEET CONTENTS	SHEET NO.
	REHABILITATION OF FISHPOND WITH ADVANCED POND FACILITIES SARAWAN, BONTUC SOUTHERN LEYTE	JOMMAR V. TAGALOG	JINKY F. LUMBRE PPOWO-RESIGNATE	GORDON B. OPINA HEAD, ADMINISTRATION	DEWOOWOGEN P. BACLAYON, Ph.D CAMPUS DIRECTOR	DIKE B DETAIL	13
	REHABILITATION OF FISHPOND WITH ADVANCED POND FACILITIES SARAWAN, BONTUC SOUTHERN LEYTE	JOMMAR V. TAGALOG	JINKY F. LUMBRE PPOWO-RESIGNATE	GORDON B. OPINA HEAD, ADMINISTRATION	DEWOOWOGEN P. BACLAYON, Ph.D CAMPUS DIRECTOR	DIKE A DETAIL	13

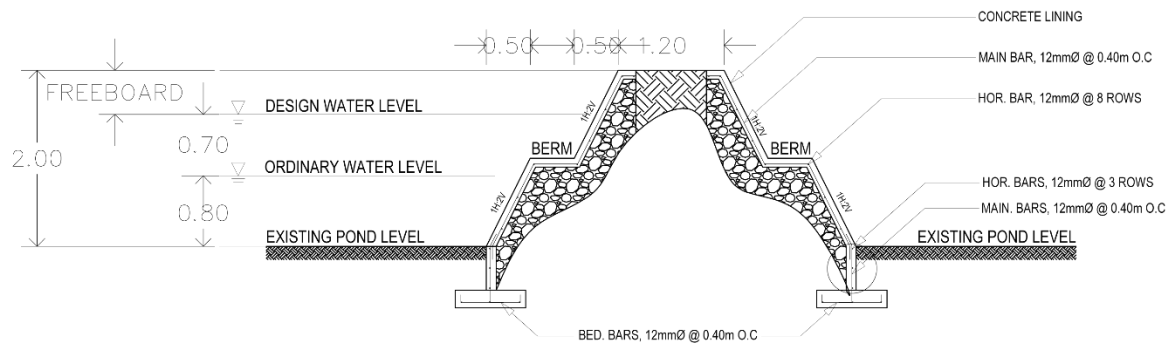

TRANSVERSE SECTION FOR DIKE B



REINFORCEMENT DETAIL FOR DIKE B

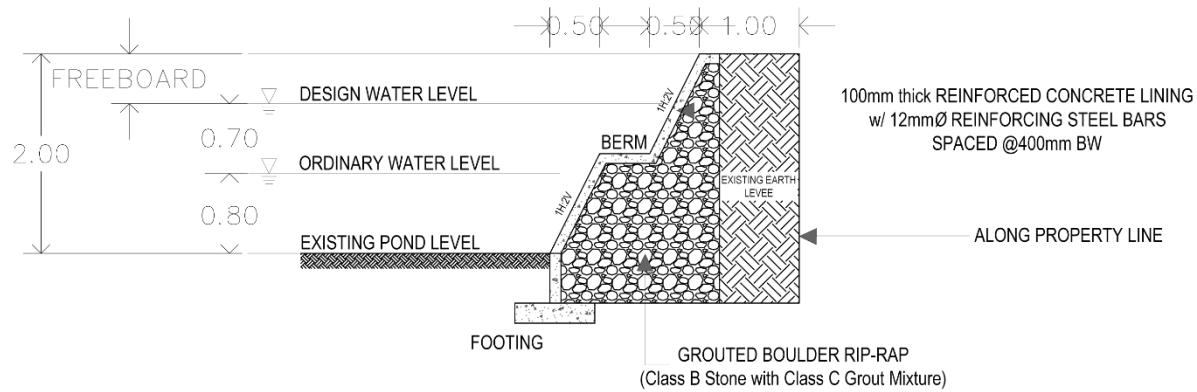

OWNER:	PROJECT TITLE:	CIVIL ENGINEER:	NOTED BY:	RECOMMENDING APPROVAL:	APPROVED BY:	SHEET CONTENTS:	SHEET NO.:
	REHABILITATION OF FISHPOND WITH ADVANCED POND FACILITIES SAN RAMON, BONTOC SOUTHERN LEYTE	JOMMAR V. TAGALOG	JINKY F. LUMBRE PPDMO-DESIGNATE	GORDON B. OPINA HEAD, ADMINISTRATION	DEWOOOGEN P. BACLAYON, Ph.D CAMPUS DIRECTOR	DIKE B DETAIL	
		PRG No.:					
		PTR No.:					
		TIN No.:					

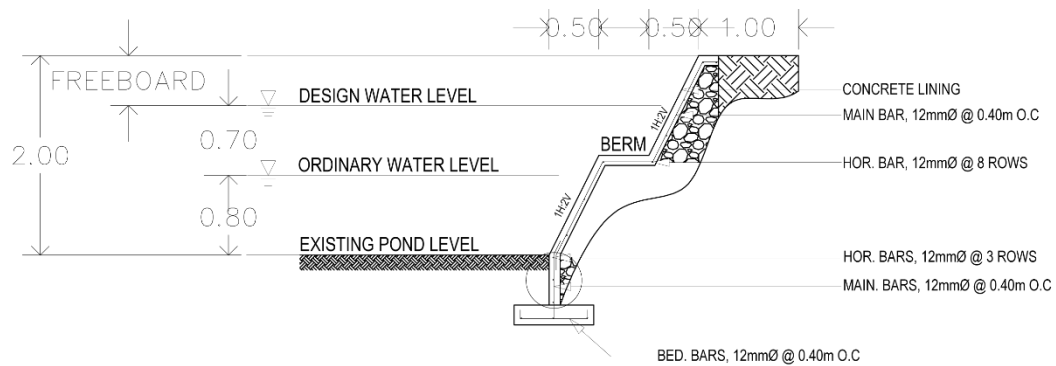

TRANSVERSE SECTION FOR DIKE C



REINFORCEMENT DETAIL FOR DIKE C

OWNER:	PROJECT TITLE:	CIVIL ENGINEER:	NOTED BY:	RECOMMENDING APPROVAL:	APPROVED BY:	SHEET CONTENTS:	SHEET NO.:
	REHABILITATION OF FISHPOND WITH ADVANCED POND FACILITIES SAN RAMON, BONTOC SOUTHERN LEYTE	JOMMAR V. TAGALOG	JINKY F. LUMBRE PPDMO DESIGNATE	GORDON B. OPINA HEAD, ADMINISTRATION	DEWOOOGEN P. BACLAYON, Ph.D CAMPUS DIRECTOR	DIKE C DETAIL	
		PRC No.					
		PTR No.					
		TIN No.					

Section VIII. Bill of Quantities

Please refer to Annex “A” & “B”

Section IX. Checklist of Technical and Financial Documents

Checklist of Technical and Financial Documents

I. TECHNICAL COMPONENT ENVELOPE

Class "A" Documents

Legal Documents

- (a) Valid PhilGEPS Registration Certificate (Platinum Membership) (all pages);
or
- (b) Registration certificate from Securities and Exchange Commission (SEC), Department of Trade and Industry (DTI) for sole proprietorship, or Cooperative Development Authority (CDA) for cooperatives or its equivalent document;
and
- (c) Mayor's or Business permit issued by the city or municipality where the principal place of business of the prospective bidder is located, or the equivalent document for Exclusive Economic Zones or Areas;
and
- (e) Tax clearance per E.O. No. 398, s. 2005, as finally reviewed and approved by the Bureau of Internal Revenue (BIR).

Technical Documents

- (f) Statement of the prospective bidder of all its ongoing government and private contracts, including contracts awarded but not yet started, if any, whether similar or not similar in nature and complexity to the contract to be bid; and
- (g) Statement of the bidder's Single Largest Completed Contract (SLCC) similar to the contract to be bid, except under conditions provided under the rules; and
- (h) Philippine Contractors Accreditation Board (PCAB) License;
or
Special PCAB License in case of Joint Ventures;
and registration for the type and cost of the contract to be bid; and
- (i) Original copy of Bid Security. If in the form of a Surety Bond, submit also a certification issued by the Insurance Commission;
or
Original copy of Notarized Bid Securing Declaration; and
- (j) Project Requirements, which shall include the following:
 - a. Organizational chart for the contract to be bid;
 - b. List of contractor's key personnel (*e.g.*, Project Manager, Project Engineers, Materials Engineers, and Foremen), to be assigned to the contract to be bid, with their complete qualification and experience data;
 - c. List of contractor's major equipment units, which are owned, leased, and/or under purchase agreements, supported by proof of ownership or certification of availability of equipment from the equipment lessor/vendor for the duration of the project, as the case may be; and

- (k) Original duly signed Omnibus Sworn Statement (OSS); **and** if applicable, Original Notarized Secretary's Certificate in case of a corporation, partnership, or cooperative; or Original Special Power of Attorney of all members of the joint venture giving full power and authority to its officer to sign the OSS and do acts to represent the Bidder.

Financial Documents

- (l) The prospective bidder's audited financial statements, showing, among others, the prospective bidder's total and current assets and liabilities, stamped "received" by the BIR or its duly accredited and authorized institutions, for the preceding calendar year which should not be earlier than two (2) years from the date of bid submission; **and**
- (m) The prospective bidder's computation of Net Financial Contracting Capacity (NFCC).

Class "B" Documents

- (n) If applicable, duly signed joint venture agreement (JVA) in accordance with RA No. 4566 and its IRR in case the joint venture is already in existence; **or** duly notarized statements from all the potential joint venture partners stating that they will enter into and abide by the provisions of the JVA in the instance that the bid is successful.

II. FINANCIAL COMPONENT ENVELOPE

- (o) Original of duly signed and accomplished Financial Bid Form; **and**

Other documentary requirements under RA No. 9184

- (p) Original of duly signed Bid Prices in the Bill of Quantities; **and**
- (q) Duly accomplished Detailed Estimates Form, including a summary sheet indicating the unit prices of construction materials, labor rates, and equipment rentals used in coming up with the Bid; **and**
- (r) Cash Flow by Quarter.

Republic of the Philippines



SLSU

SOGOD. SOUTHERN LEYTE